

N-沟道功率 MOS 管/ N-CHANNEL POWER MOSFET < A ' B+\$

- 特点：热阻低 开关速度快 输入阻抗高 符合RoHS规范
- FEATURES: ■LOW THERMAL RESISTANCE ■FAST SWITCHING ■HIGH INPUT RESISTANCE
■RoHS COMPLIANT
- 应用：电子镇流器 电子变压器 开关电源
- APPLICATION: ■ELECTRONIC BALLAST ■ELECTRONIC TRANSFORMER ■SWITCH MODE POWER SUPPLY

●最大额定值 (TC=25°C)

●Absolute Maximum Ratings (Tc=25°C) TO-251/252

参数 PARAMETER	符号 SYMBOL	额定值 VALUE	单位 UNIT
漏-源电压 Drain-source Voltage	V _{DS}	700	V
栅-源电压 gate-source Voltage	V _{GS}	±30	V
漏极电流 Continuous Drain Current TC=25°C	I _D	3.0	A
漏极电流 Continuous Drain Current TC=100°C	I _D	2.3	A
最大脉冲电流 Drain Current – Pulsed ①	I _{DM}	12	A
耗散功率 Power Dissipation	P _{tot}	36	W
最高结温 Junction Temperature	T _j	150	°C
存储温度 Storage Temperature	T _{STG}	-55-150	°C
单脉冲雪崩能量 ② Single Pulse Avalanche Energy	E _{AS}	260	mJ

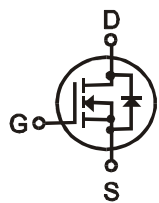

V_{DS}=700V

R_{DS(ON)}=3.0 Ω

I_D=3.0A

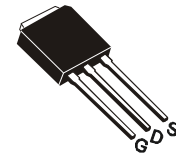

TO-251(IPAK)

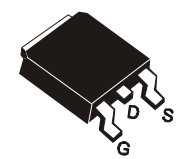

TO-252(DPAK)

●电特性 (Tc=25°C)

●Electronic Characteristics (Tc=25°C)

参数 PARAMETER	符号 SYMBOL	测试条件 TEST CONDITION	最小值 MIN	典型值 TYP	最大值 MAX	单位 UNIT
漏-源击穿电压 Drain-source Breakdown Voltage	BV _{DSS}	V _{GS} =0V, I _D =250μA	700			V
击穿电压温度系数 Breakdown Voltage Temperature Coefficient	ΔBV _{DSS} /ΔT _j	I _D =250uA, Referenced to 25°C		0.65		V/°C
栅极开启电压 Gate Threshold Voltage	V _{GS(TH)}	V _{GS} =V _{DS} , I _D =250μA	2.0		4.0	V
漏-源漏电流 Drain-source Leakage Current	I _{DSS}	V _{DS} =700V, V _{GS} =0V, T _j =25°C			1	μA
		V _{DS} =560V, V _{GS} =0V, T _j =125°C			10	μA
跨导 Forward Transconductance	g _{fs}	V _{DS} =40V, I _D =2.0A ③		4.0		S

●订单信息/ORDERING INFORMATION:

包装形式/PACKING	订货编码/ORDERING CODE	
	普通塑封料 Normal Package Material	无卤塑封料 Halogen Free
TO-252 或 251 或 251S 条管装/TUBE PACKING	PT 3N700S TO-251-TU 或 TO-251S-TU 或 TO-252-TU	PT 3N700S TO-251-TU-HF 或 TO-251S-TU-HF 或 TO-252-TU-HF
TO-252 编带装 /TAPE & REEL PACKING	PT 3N70S TO-252-TR	HM3N70K TO-252-TR-HF

参数 PARAMETER	符号 SYMBOL	测试条件 TEST CONDITION	最小值 MIN	典型值 TYP	最大值 MAX	单位 UNIT
栅极漏电流 Gate-body Leakage Current ($V_{DS} = 0$)	I_{GSS}	$V_{GS} = \pm 30V$			± 100	nA
漏-源导通电阻 Static Drain-source On Resistance	$R_{DS(ON)}$	$V_{GS} = 10V, I_D = 1.5A$ ③			3.0	Ω
输入电容 Input Capacitance	C_{iss}	$V_{GS} = 0V, V_{DS} = 25V$ $F = 1.0MHz$		520		pF
关断延迟 Turn -Off Delay Time	$T_d(off)$	$V_{DD} = 350V, I_D = 3.0A$ $R_G = 25\Omega$ ③		25		ns
栅极电荷 Total Gate Charge	Q_g	$I_D = 3.0A, V_{DS} = 560V$ $V_{GS} = 10V$ ③		17.5		nC
栅源电荷 Gate-to-Source Charge	Q_{gs}			4.8		nC
栅漏电荷 Gate-to-Drain Charge	Q_{gd}			5.4		nC
二极管正向电流 Continuous Diode Forward Current	I_S				3.0	A
二极管正向压降 Diode Forward Voltage	V_{SD}	$T_j = 25^\circ C, I_S = 3.0A$ $V_{GS} = 0V$ ③			1.4	V
反向恢复时间 Reverse Recovery Time	t_{rr}	$T_j = 25^\circ C, I_f = 3.0A$ $di/dt = 100A/\mu s$ ③		250		ns
反向恢复电荷 Reverse Recovery Charge	Q_{rr}			1.5		μC

●热特性

●Thermal Characteristics

参数 PARAMETER	符号 SYMBOL	最大值 MAX	单位 UNIT
		TO-251/252	
热阻结-壳 Thermal Resistance Junction-case	R_{thJC}	3.47	$^\circ C/W$
热阻结-环境 Thermal Resistance Junction-ambient	R_{thJA}	62.5	$^\circ C/W$

注释(Notes):

- ① 脉冲宽度：以最高节温为限制
Repetitive rating: Pulse width limited by maximum junction temperature
- ② 初始结温= $25^\circ C$, $V_{DD} = 50V$, $L = 30mH$, $R_G = 25\Omega$, $I_{AS} = 3.0A$
Starting $T_j = 25^\circ C$, $V_{DD} = 50V$, $L = 30mH$, $R_G = 25\Omega$, $I_{AS} = 3.0A$
- ③ 脉冲测试：脉冲宽度 $\leq 300\mu s$ ，占空比 $\leq 2\%$
Pulse Test : Pulse width $\leq 300\mu s$, Duty cycle $\leq 2\%$

● 特性曲线



图 1 输出特性曲线, Tc=25°C

Fig1 Typical Output Characteristics, Tc=25°C

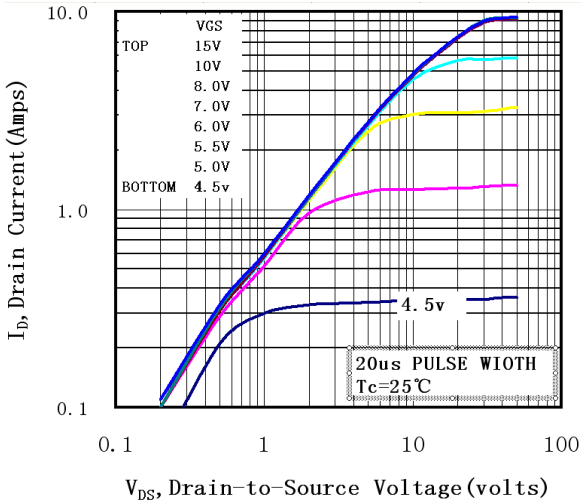

图 2 输出特性曲线, Tc=150°C

Fig2 Typical Output Characteristics, Tc=150°C

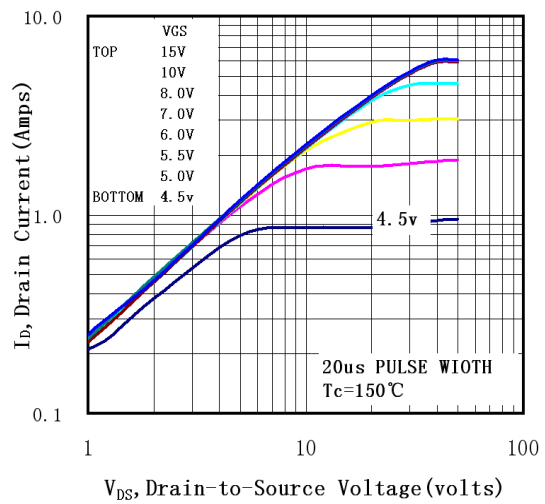

图 3 归一化导通电阻与温度曲线

Fig3 Normalized Resistance Vs. Temperature

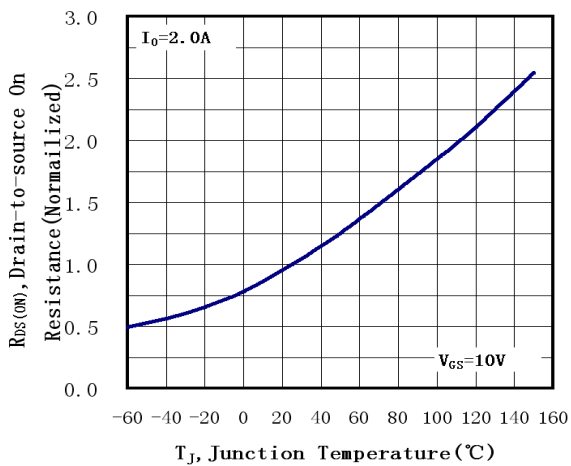

图 4 二极管正向电压曲线

Fig4 Typical Source-Drain Diode Forward Voltage

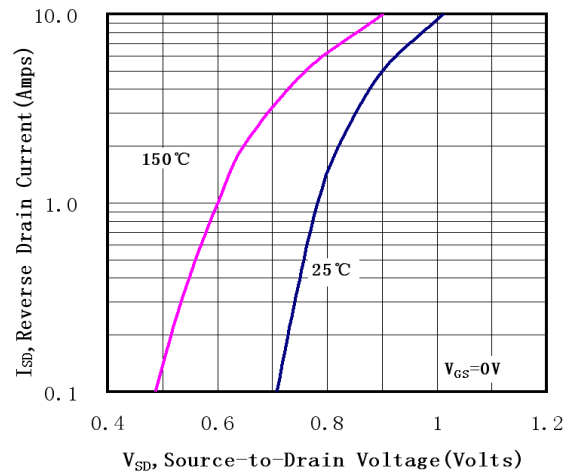

图 5 最大漏极电流与壳温曲线

Fig5 Maximum Drain Current Vs. Case Temperature

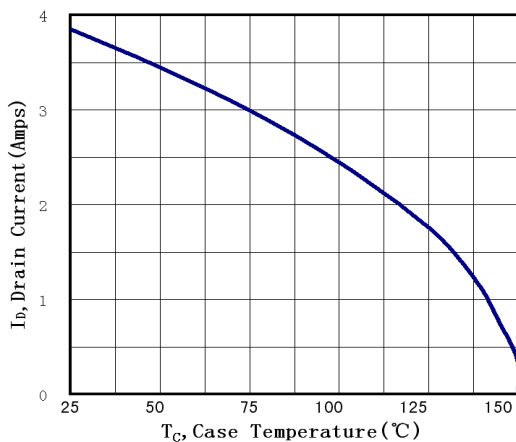

图 6 最大安全工作区曲线

Fig6 Maximum Safe Operating Area

TO-251 封装机械尺寸
TO-251 (IPAK) MECHANICAL DATA

单位:毫米/UNIT: mm

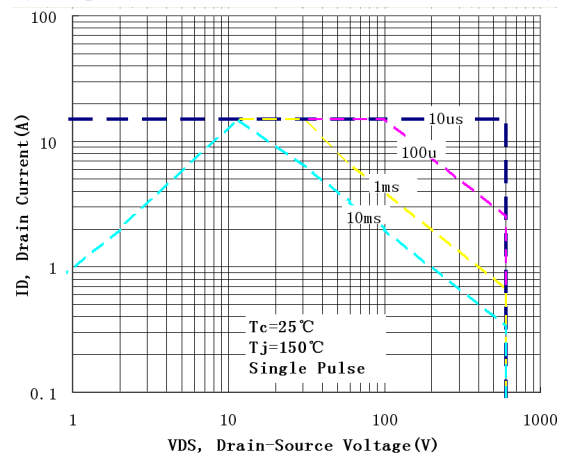
符号/SYMBOL	最小值/min	典型值/nom	最大值/max
A	2.10		2.50
A ₁	0.95		1.30
B	0.80		1.25
b	0.50		0.80
b ₁	0.70		0.90
c	0.45		0.70
c ₁	0.45		0.70
D	6.35		6.80
D ₁	5.10		5.50
E	5.30		6.30
e		2.30	
L	7.00		9.20
R		0.30	

[S/L]

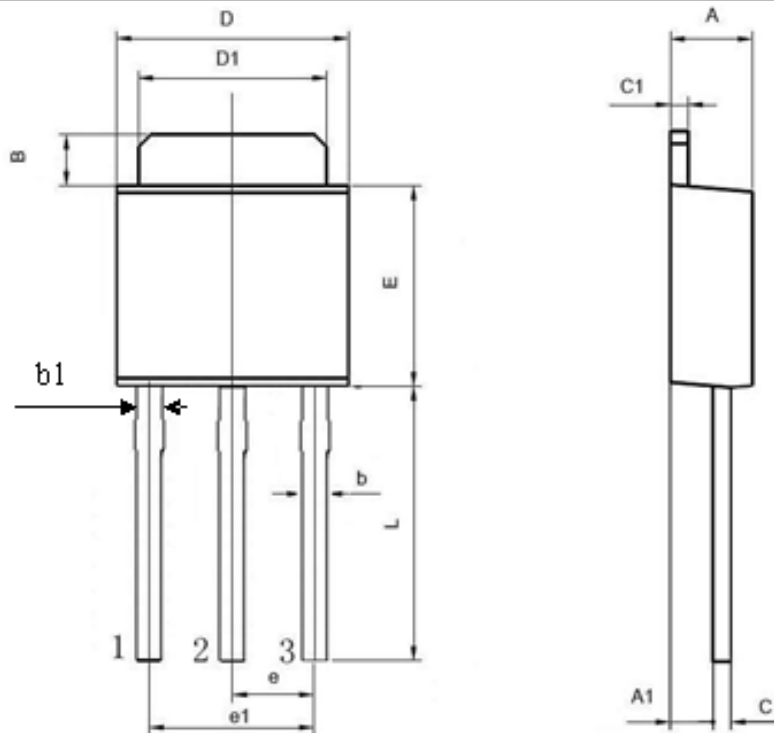

TO-252 封装机械尺寸
TO-252 MECHANICAL DATA

单位:毫米/UNIT: mm

符号 SYMBOL	最小值 min	最大值 max	符号 SYMBOL	最小值 min	最大值 max
A	2.10	2.50	B	0.85	1.25
b	0.50	0.80	b1	0.50	0.90
b2	0.45	0.70	C	0.45	0.70
D	6.30	6.75	D1	5.10	5.50
E	5.30	6.30	e1	2.25	2.35
L1	9.20	10.60	e2	4.45	4.75
L2	0.90	1.75	L3	0.60	1.10
K	-0.10	0.10			

